

F10 Fresh Master Conic On Demand

Updated 21/10/2020

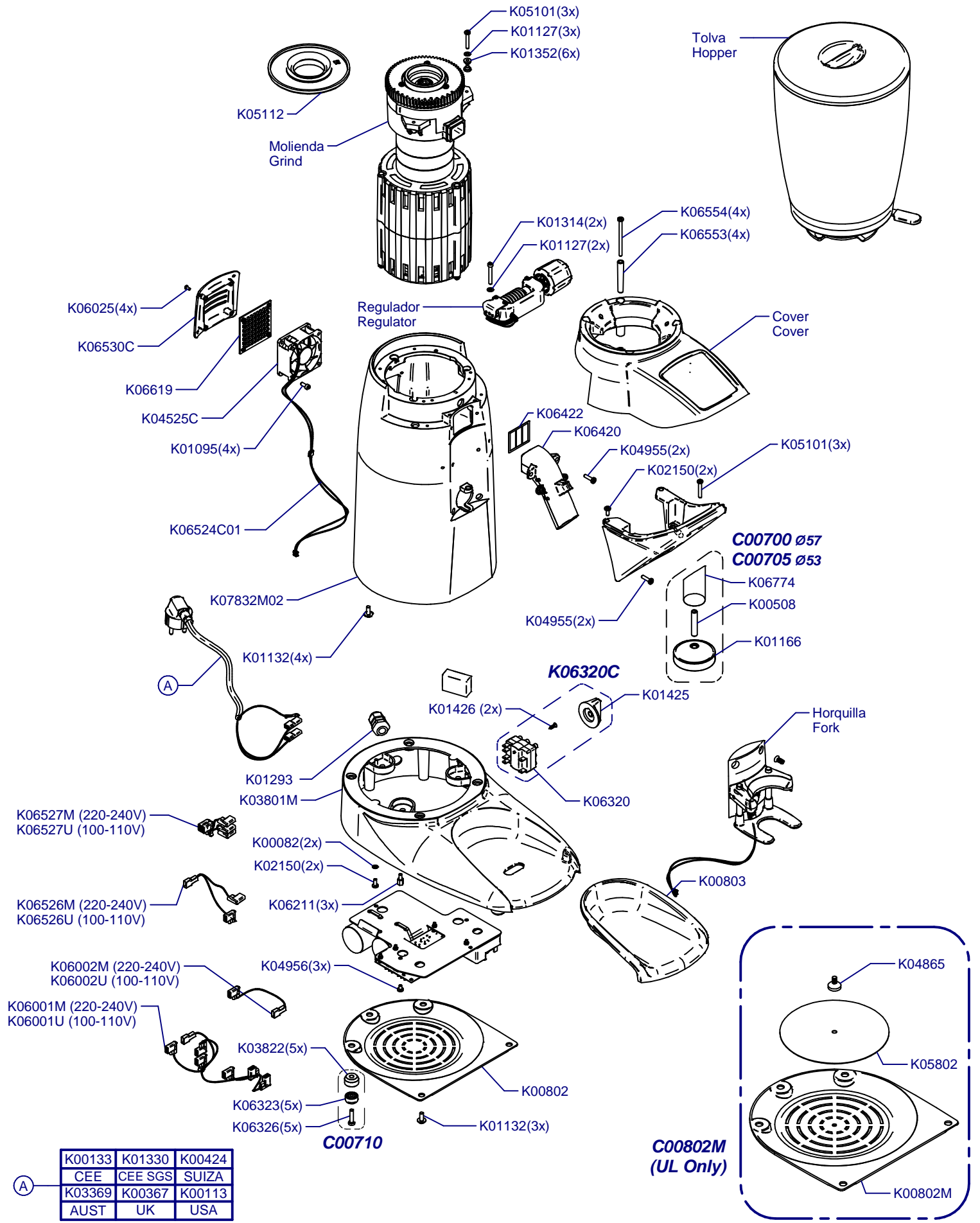

Tolva / Hopper

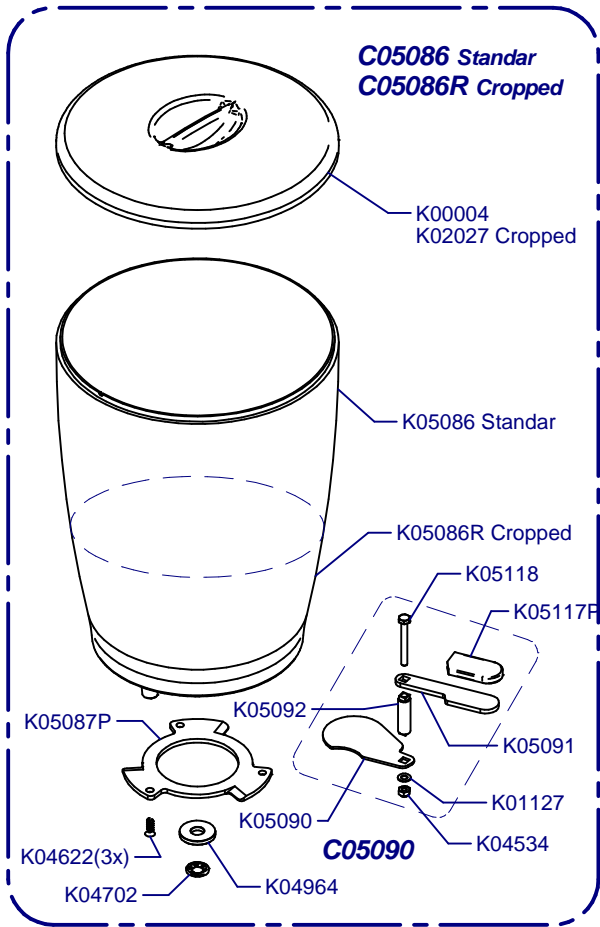

Horquilla / Fork

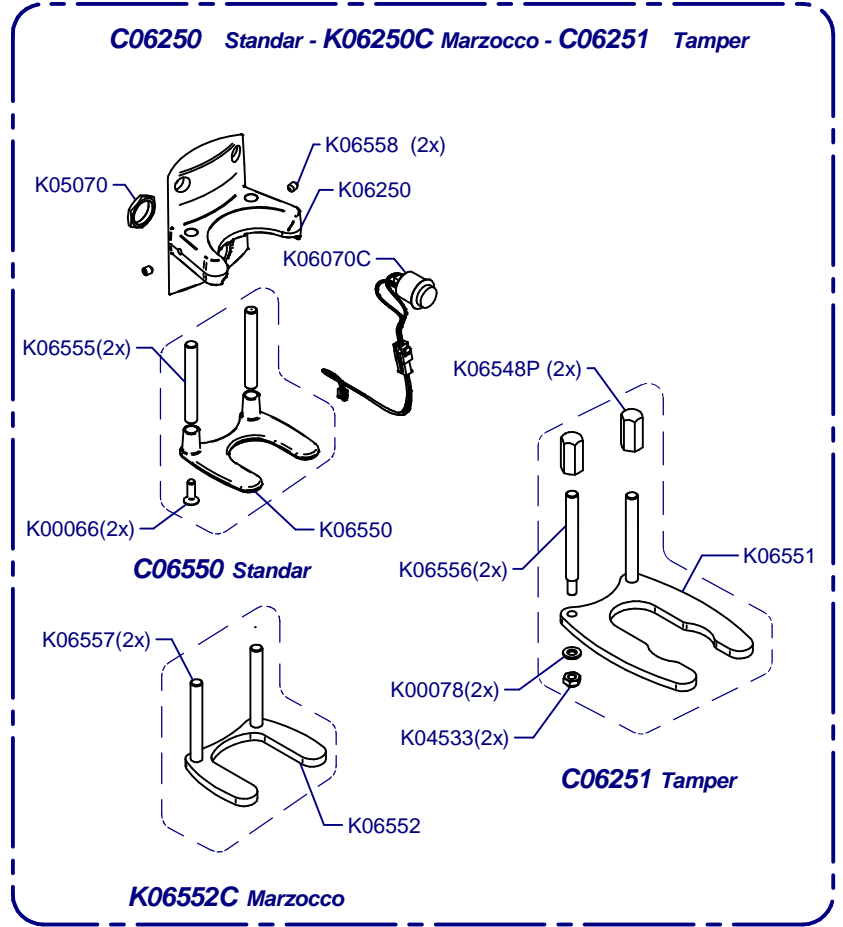

Cover / Cover

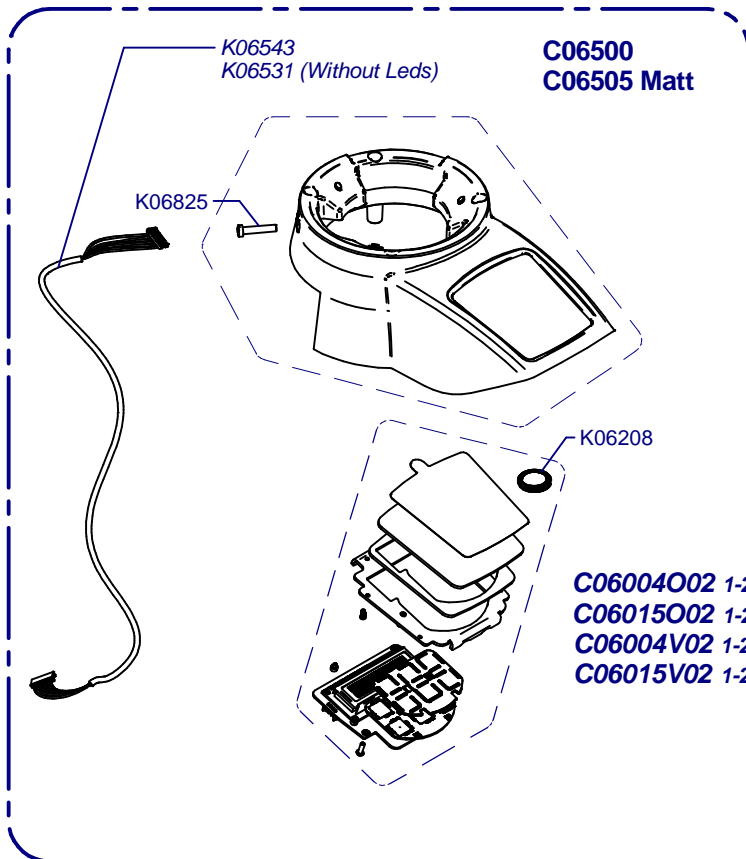

Regulador / Regulator

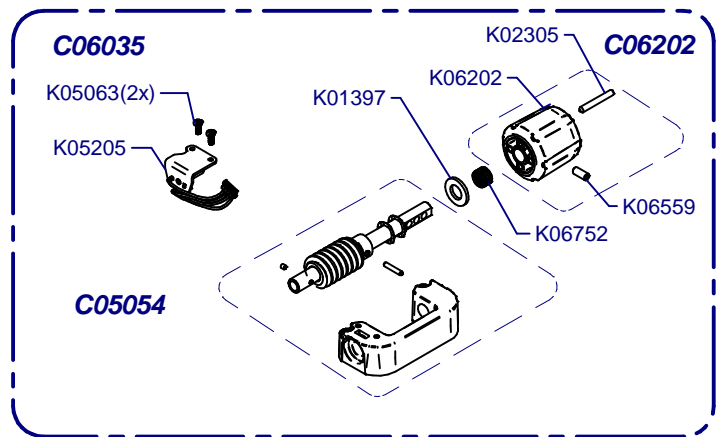

Portafilter Detector

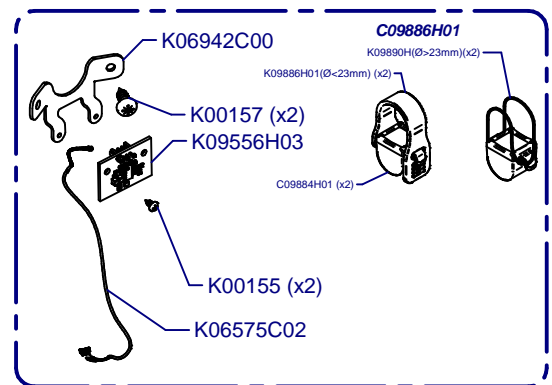

F10 Fresh Master Conic On Demand

Updated 21/10/2020

Molienda / Grind

C00620 Aluminium

C00625 Brass

C00620N Niquel

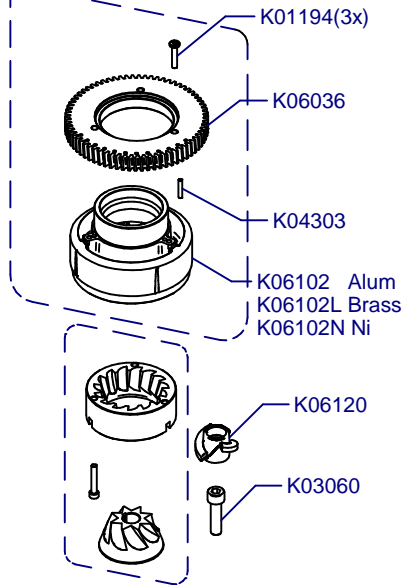

K03178C Red Speed

K03078C Standard

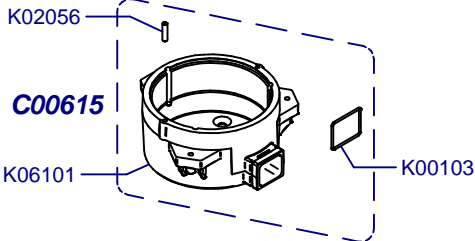

C00615

K03271

K03057

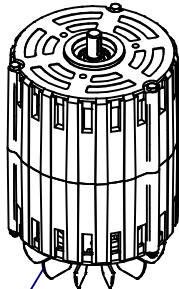

K03815 (100/110V)
K03817 (220/240V)
K03818 (208/400V)

C00633 = C00620 + C00615 Alum
C00632 = C00625 + C00615 Bras
C00633N = C00620N + C00615 Ni

Placa Base / Mother Board

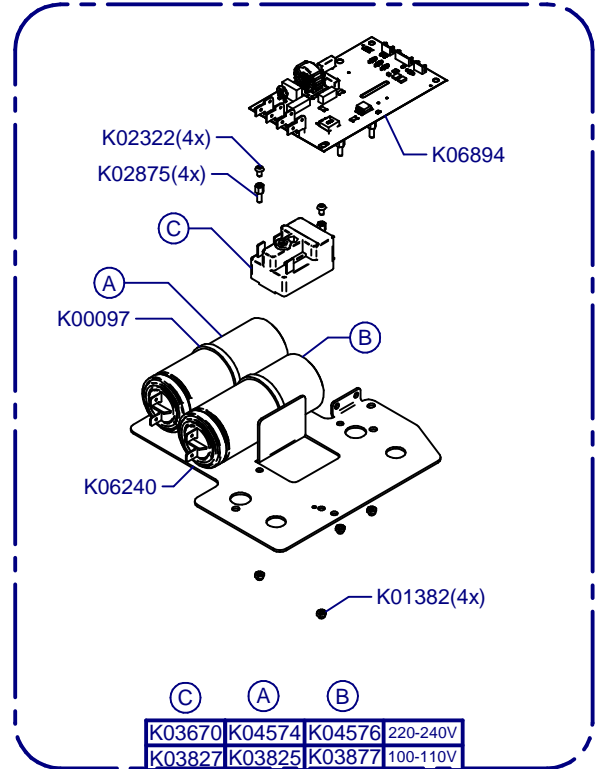

C00530 (220-240V)

C00535 (100-110V)

Prensa Regulable / Adjustable Tamper

C06756 Ø53 Right
C06757 Ø53 Left
C06758 Ø54 Right
C06759 Ø54 Left
C06760 Ø57 Right
C06761 Ø57 Left

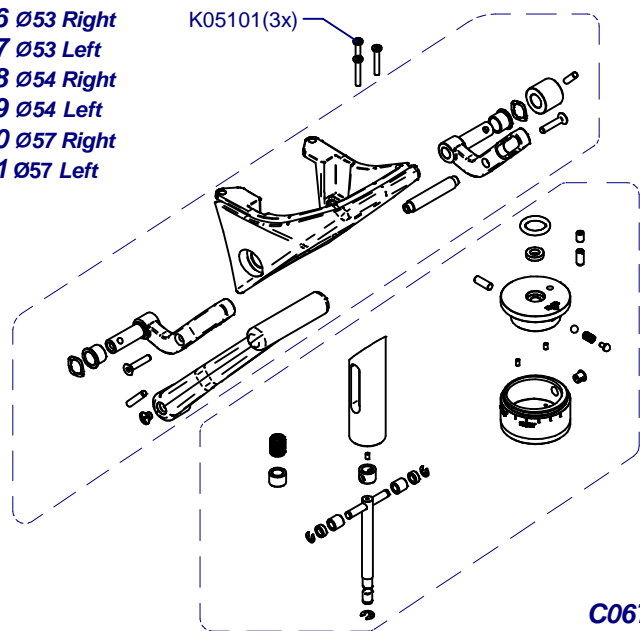

C06746 Left
C06745 Right

C06743 Ø57
C06744 Ø54
C06755 Ø53