

K10 Conic Professional Barista

Updated 06/05/2014

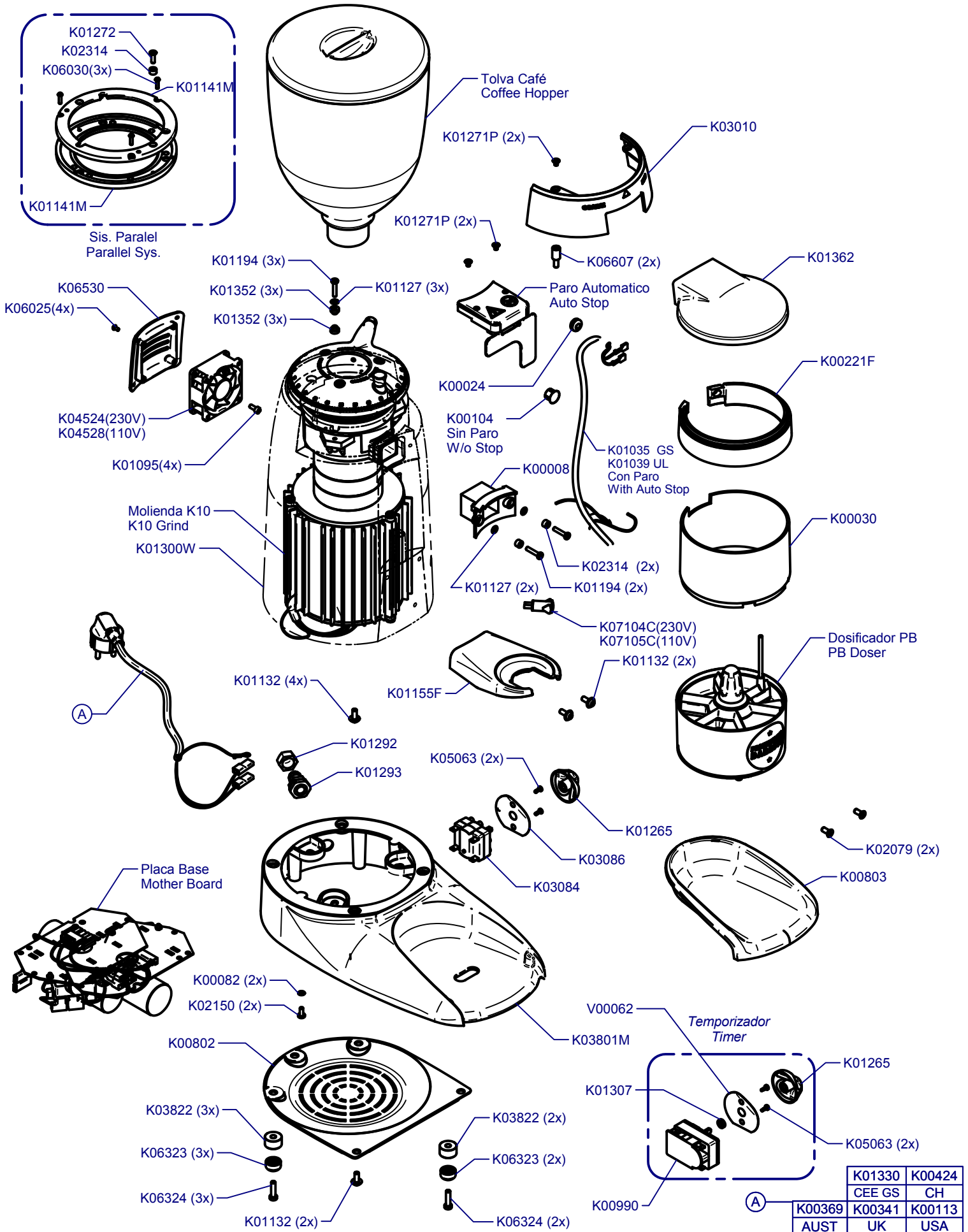

K01330	K00424
CEE GS	CH
K00369	K00341
AUST	UK
	K00113
	USA

K10 Conic Professional Barista

Updated 06/05/2014

Dosificador Aluminio/ Aluminium Doser

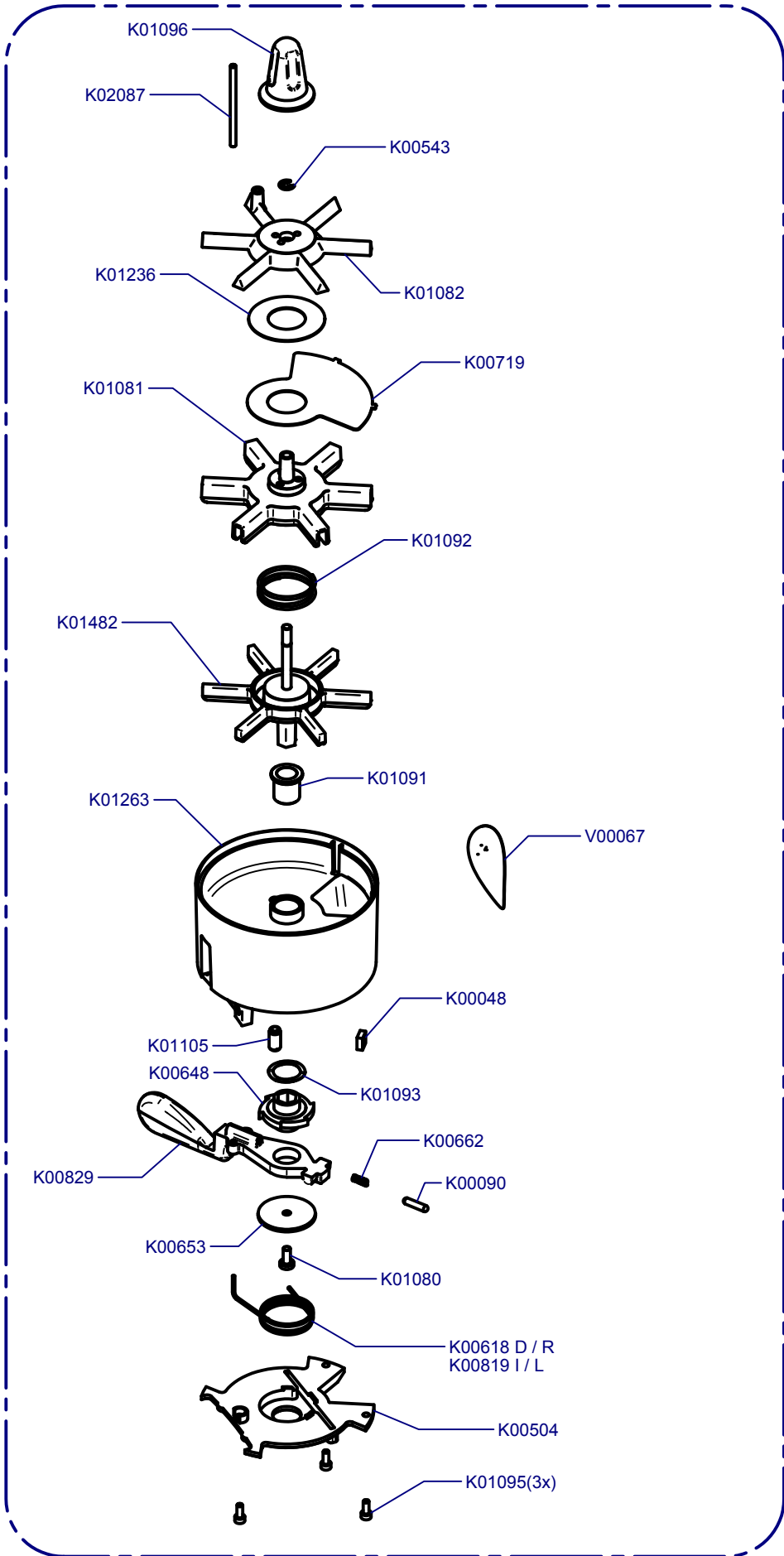

Tolva Café / Coffee Hopper

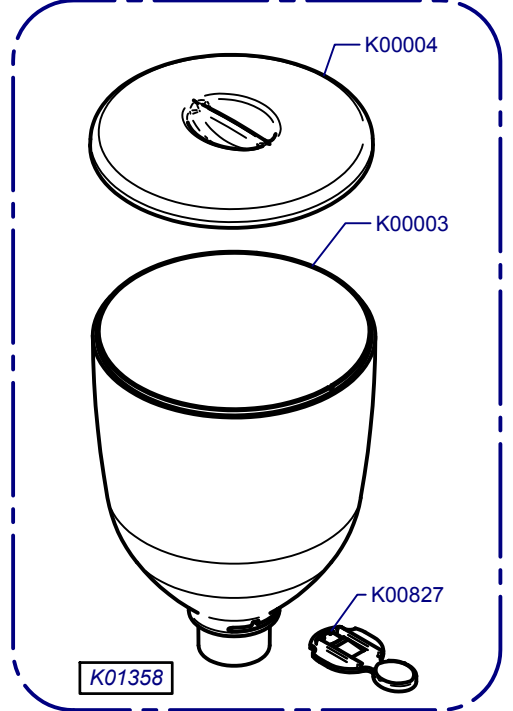

Tolva Café 275gr / Coffee Hopper 275gr

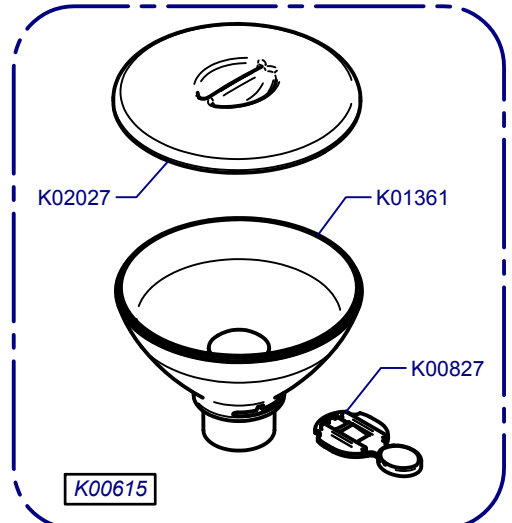

Paro Automático / Auto Stop

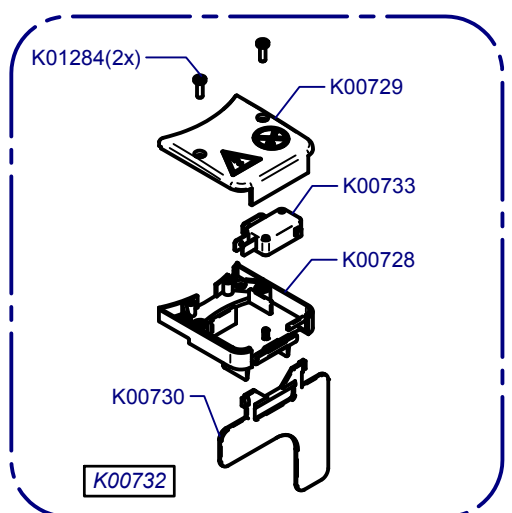

K10 Conic Professional Barista

Updated 06/05/2014

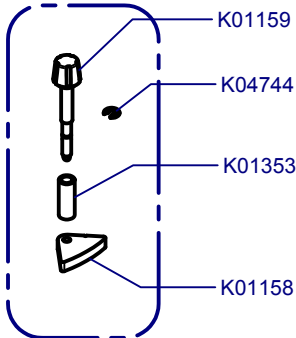

Sis. Paralel
Parallel Sys.

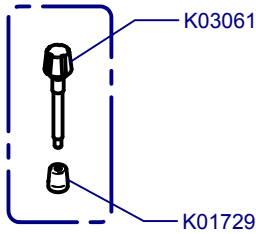

Sis. Micrometrico
Micrometric Sys.

(*) Sis. Punto a Punto
Stepped Sys.

Placa Base / Mother Board

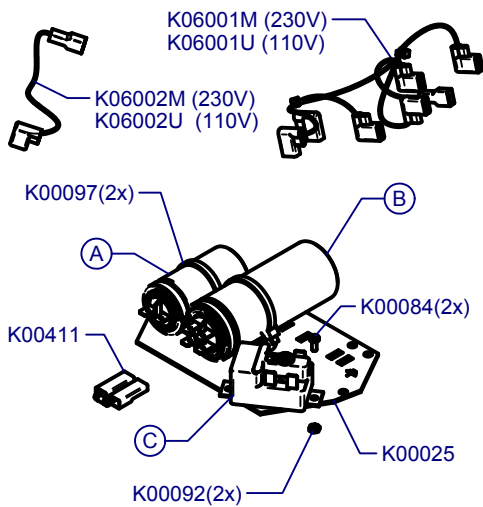

C	
K00496	230-240V
K00488	220V
K03175	110V
K03824	100V

A	B	
K05108	K04574	230-240V
K05108	K04574	220V
K03174	K03878	110V
K03825	K03877	100V

Molienda / Grind

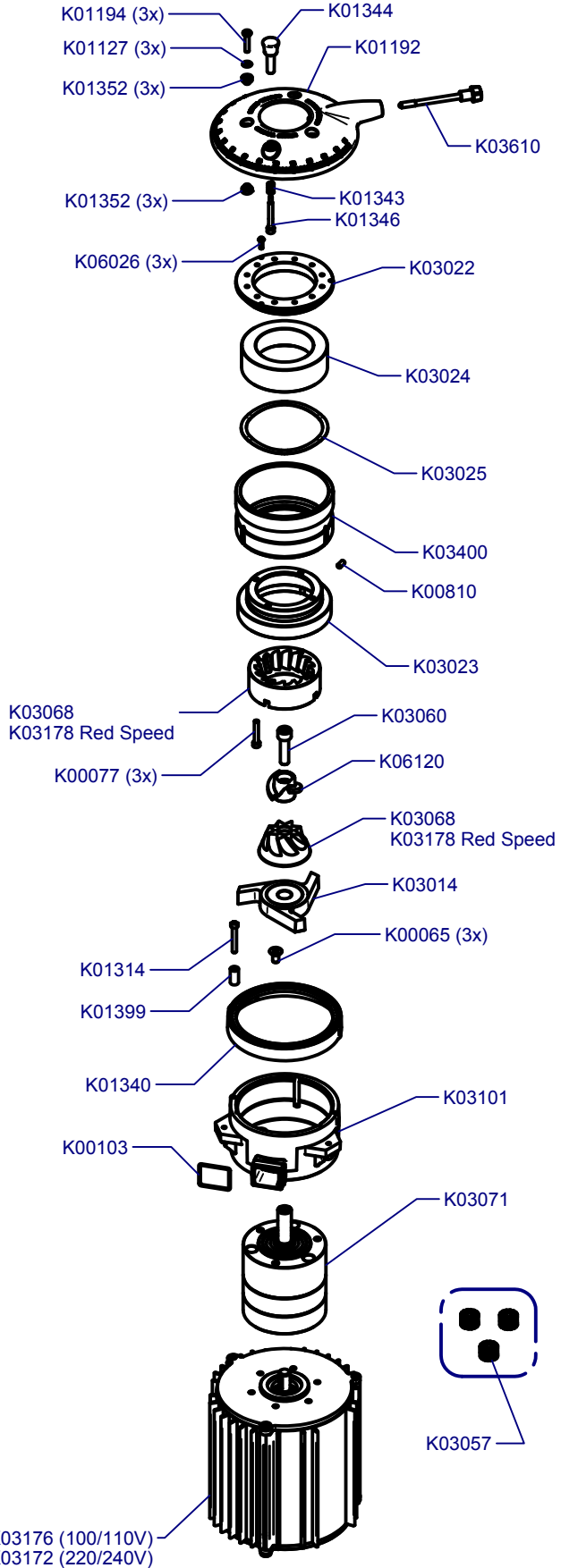

K03057

K03176 (100/110V)
K03172 (220/240V)